



KF Industries is a Brand of
 Circor Energy Products, Inc.,
 a leading Global manufacturer of
 gas & oil pressure control
 products. Applications range from
 the Wellhead to the Pipeline both
 onshore and offshore.
 Products produced include ball,
 check, gate, globe, needle,
 butterfly valves and
 pipeline closures.
 Markets Served include
 Oil & Gas, Petrochemical,
 Power Generation and Industrial.

Contents

Ball Valves • Floating

Threaded, Grooved & Socket weld
 Series A, AH, C, CH, CXH, CA, CAH, CB, CBH, E, EH & EC 4
 Commodity Ball Valves
 Series HC-730, 740 & 710, HS-810 & 820 & HB-600 5
 Threaded Bolted Body
 Series AF, AFH, CF, CFH & CFXH 5
 Threaded End, Series B, BH & W 6
 Flanged End, Series F 6

Ball Valves • Trunnion Mounted, Flanged

Top Entry, Series T 7
 Three-Piece, Series P3 7
 Two-Piece, Series FA 7

Check Valves

Wafer, Threaded, Flanged, Piston & Ball 8, 9

Needle Valves

Packed & O-Ring Style 9

Isolator Valves

Threaded & Flanged Series AIV 9

Butterfly Valves

Wafer & Lug Series BG, One-Piece Series 2200 10

Specialty Ball Valves

Series K1 & K3 Ball Valves 11

Gate, Globe & Check Valves

Rubber Seated Gate Valves, Series TG 11
 Forged & Cast Steel Gate, Globe & Check Valves 11

Closures (Pipeline)

Series TC 11

When quality counts, *Specify KF Industries.*



Our Quality Commitment

We're dedicated to providing our customers with technically superior products that are designed, manufactured, and tested to the exacting standards of various qualifying authorities. Other additional non-destructive or destructive examination may be performed to customer requirements or specifications. Please contact KF Industries for additional information and clarification.

Ask your KF Representative about our complete line of technically superior flow control products.

Specifications Conformance

KF valves are designed, manufactured and tested in accordance with API, ANSI and ASME requirements. The following list contains the most important applicable standards. KF valves may be produced in accordance with other standards on request.

ANSI-American National Standard Institute

- B 1.20.1 Pipe threads, general purpose.
- B 16.5 Steel pipe flanges and flanged fittings.
- B 16.10 Face-to-face and end-to-end dimensions of ferrous valves.
- B 16.25 Butt welding ends.
- B 16.34 Steel valves-flanged and butt welding ends.

API-American Petroleum Institute

- Spec. 6A Specification for wellhead valves.
- Spec. 6D Specification for pipeline valves.
- Spec. 6FA Specification for fire testing of valves.
- Std. 607 Fire test for soft seated quarter-turn valves.
- Spec. Q1 Quality program.
- Spec. 5B EUE External upset tubing threads.

ISO 9001-International Organization for Standardization

- ISO 9001 Quality systems-model for quality assurance in design, development, production, installation and servicing.
- ISO 15156 Materials for use in H₂S containing environments in oil & gas production.

MSS-Manufacturers Standardization Society

- SP 6 Standard finishes for contact faces of pipe flanges and connecting-end flanges of valves and fittings.
- SP 25 Standard marking system for valves, fittings, flanges and unions.
- SP 55 Quality standard for steel castings.

NACE-National Association of Corrosion Engineers

- MR0175 Sulfide stress cracking resistant metallic materials for oilfield equipment.

KF Industries reserves the right to change designs, materials or specifications without notice or without obligation to furnish or install such changes on products previously or subsequently sold.



KF Threaded & Grooved-End Floating Ball Valves

Features

- Full & Reduced Port
- Threaded & Grooved End Connections
- External Grease Fitting For Stem Journal Lubrication
- Weather Seal (Stem)
- Firesafe API 607 4th Edition
- Blowout Proof Stem Design
- Heavy Duty Flatted Stem Design
- Metal-To-Metal Firesafe Sealing
- Integral Locking Device
- Manual Operation Handle

Optional Features

- AntiStatic Device
- Actuation & Square Nut Assemblies
- Enduro-Bond™ Coating For Corrosion Resistance
- Valves Specified with Stainless Steel Trim Meet NACE MR0175
- Anti-Freeze Design*

*Available upon request.

Series A & AH

Ductile Iron Body
 Series A - 1"FP - 4"RP, 1000-1500 psi
 Series AH - 1"FP - 3"RP, 1500-2000 psi



Series C, CH & CXH

Carbon or Stainless Steel Body
 Series C - 1"FP - 4"FP, 1000-2500 psi
 Series CH - 1"FP - 4"FP, 2000-3000 psi
 Series CXH - 1"FP - 2"RP, 5000 psi

Series CA & CAH

Carbon Steel Body,
 2³/₈ EUE X 2¹/₁₆ Bore & 2⁷/₈ EUE X 2⁹/₁₆ Bore
 Series CA - 1000-2000 psi
 Series CAH - 3000 psi

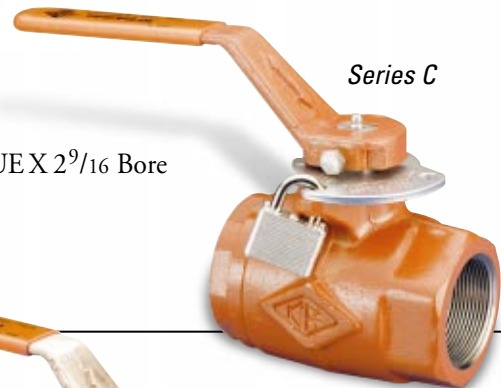

Series CB & CBH

Nickel Aluminum Bronze Body
 1"FP - 2"FP
 Series CB - 1000-2500 psi
 Series CBH - 3000 psi



Series E, EH & EC

Series E - Ductile Iron Body, 2"RP - 4"RP, 750 CWP
 Series EH - Ductile Iron Body, 2"RP - 4"RP, 1000 CWP
 Series EC - Stainless Steel Body, 2"RP - 3"RP, 750 PSI



Note: Padlocks not included.
 Consult Factory.



KF Commodity Ball Valves

Series HC-730, 740 & 710, Features HS-810 & 820 & HB-600

HC-730 - Carbon Steel Unibody,
1/2" - 2", 1500-2000 CWP

HC-740 - Carbon Steel Two-Piece,
1/4" - 2", 1500-2000 CWP

HC-710/HS-810 - Carbon & Stainless
Steel Unibody, 1/4" - 2", 2000 CWP

HS-820 - Stainless Steel Seal Welded
Two-Piece, 1/4" - 2", 2000 CWP

HB-600 - Bronze Two-Piece
1/4" - 4", 400-600 CWP

- Two-Piece & Unibody, Cast, Investment Cast & Bar Stock Body
- Designed For Hydraulic Hook-Ups, Offshore Applications, Well Heads, Production Lines, Petroleum & Chemical Plant Applications
- Chrome Plate Ball
- Reinforced PTFE Seats
- Blowout Proof Stem
- Optional Locking Device



KF Floating Threaded Bolted Body Ball Valves

Features

- Full & Reduced Port
- Threaded End Connections
- Bolted Body Adapter Connection
- External Grease Fitting For Stem Journal Lubrication
- Weather Seal (Stem)
- Firesafe API 607 4th Edition

- Blowout Proof Stem Design
- Heavy Duty Flatted Stem Design
- Metal-To-Metal Firesafe Sealing
- Integral Locking Device
- Manual Operation Handle

Optional Features

- Antistatic Device
- Actuation & Square Nut Assemblies
- Enduro-Bond™ Coating For Corrosion Resistance
- Valves Specified With Stainless Steel Trim Meet NACE MR0175

Series AF & AFH

Ductile Iron Body

Series AF - 2"RP - 4"RP, 1000-1500 psi

Series AFH - 2"RP - 3"RP, 2000 psi

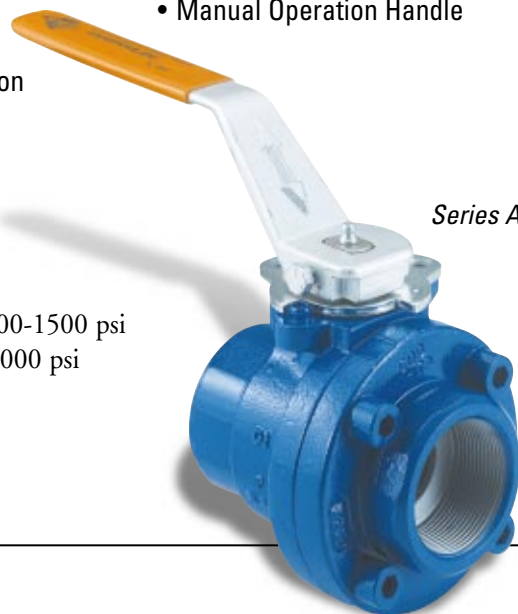

Series AF

Series CF, CFH & CFXH

Carbon Steel Body

Series CF - 2"RP - 4"FP, 1500-2500 psi

Series CFH - 2"RP - 4"FP, 3000 psi

Series CFXH - 2"RP & 2"FP, 5000 psi



Series CFXH



KF Threaded End Floating Ball Valves

Features

- Full & Reduced Port
- Threaded End Connections
- Weather Seal (Stem)
- Blowout Proof Stem Design
- Heavy Duty Flatted Stem Design
- Metal-To-Metal Firesafe Sealing
- Manual Operation Handle

Optional Features

- Antistatic Device
- Actuation & Square Nut Assemblies
- Enduro-Bond™ Coating For Corrosion Resistance
- Valves Specified With Stainless Steel Trim Meet NACE MR0175

Series B & BH • 3-Piece Design

Carbon, Stainless or Low Temp Carbon Steel Body

Series B - 1/4"FP - 2"RP, 2250 - 3000 psi

Series BH - 1/4"FP - 1"FP, 5000 psi

Series B

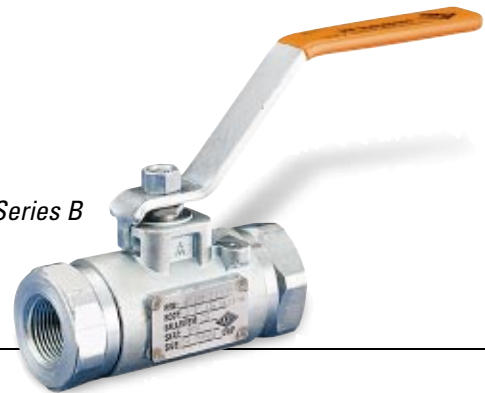

Series W

Carbon or Stainless Steel Body

1/4"FP - 2"RP, 1500 - 2000 CWP

Series W



KF Flanged End Floating Ball Valves

Features

- NACE MR0175 (ISO 15156) (SS Ball/Stem Configuration)
- Weather Seal (Class 600 & Higher)
- Actuator Mounting Pad (4 Bolt Machined)
- API 6D Monogrammed, API 607 4th Edition* (O-Ring & Graphite)
- Secondary Metal-to-Metal Sealing
- Full Rated Bi-Directional Dead End Service
- Antistatic Device
- Lockable Handle
- O-Ring Design (Std.)
- Graphite Or Teflon® Packing (Optional For Class 150 & 300)

*Not applicable to Teflon® packed.

Series F

Carbon, Stainless or Low Temp Carbon Steel Body

1"FP - 12"RP, Class 150, 300, 600, 900 & 1500

Series F



KF Trunnion Supported Ball Valves

Features

- Double Block & Bleed
- Blowout Proof Stem Design
- Corrosion Resistant Low Friction Bearings
- Inconel Wave Springs Assist In Low Pressure Sealing
- Firesafe Trim
- 3 mil ENP Ball, Stem & Seat Carriers
- Stainless Steel Injection Fittings For Emergency Stem Or Seat Sealant & Lubrication Maintenance
- Minimized Torque Required To Open & Close Valve
- Antistatic Grounding Between Ball, Stem & Body
- NACE MR0175 (ISO 15156)
- Integral Topworks Direct Mounting Pad
- 8" & Larger Valves Are Equipped With Lifting Lugs
- Bi-Directional

Series T Top Entry (Inline Repairable)

Top Entry One-Piece Carbon Steel, Low Temp Carbon Steel or Stainless Steel Body
2"FP - 16"FP, Class 600
2"FP - 12"FP, Class 900, 1500 & 2500
2¹/₁₆"FP - 7¹/₁₆"FP, API 2000, 3000 & 5000



Series P3 • 3-Piece Design

Three-Piece Carbon Steel, Low Temp Carbon Steel or Stainless Steel Body
14"FP - 24"FP, Class 150 & 300
2"FP - 36"FP, Class 600
2"FP - 24"FP, Class 900
2"FP - 12"FP, Class 1500 & 2500



Series FA • 2-Piece Design

Two-Piece Carbon Steel, Low Temp Carbon Steel or Stainless Steel Body
2"FP - 14"RP, Class 150 & 300



KF Check Valves

Features

- Long Pattern
- Short Pattern
- Single Disc
- Internal Spring Assist
- No Spring Assist
- External Spring Assist
- Air Cushion

Specifications

ANSI B16.34 & B16.5
API 6D (Monogrammed)
API 607 4th Edition
API 594, 6A & 6FD

Certified

CE Mark (Optional)
NACE MR0175
ISO 15156

Series 10 & 10S

2"-72", ANSI Class 150, 300, 600, 900, 500 & 2500, API 2000, 3000 & 5000
Wafer Long Pattern Single Disc, Internal Spring Assist
NACE MR0175 (ISO 15156) & CE Mark



Series 10

Series 12

2"-24", ANSI Class 150, 300, 600 & 900
Wafer Short Pattern
Single Disc, No Spring Assist



Series 12

Series 18

4"-12", ANSI Class 125 & 150
Wafer Style, External Spring Assist w/Back Flush Lever
ANSI B16.1 & B16.5



Series 18

Series 20 & 22

2"-72", ANSI Class 125 & 150
Wafer Semi-Lug Single Disc External Spring Assist, Air Cushion (Series 22 only)
ANSI B16.1 & B16.47

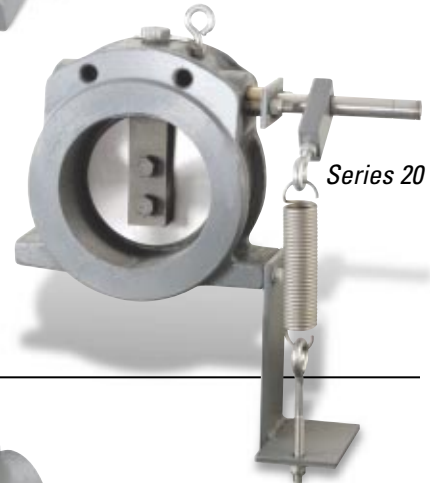

Series 20

Series 31

1"-4", MOP 300, 750, 2200, 3000 & 5000 psi
Threaded and Grooved Ends, Single Disc, No Spring Assist
NACE MR0175 (ISO 15156)



Series 31



KF Check Valves (cont.)

Series 35

2" - 24", ANSI Class 150, 300, 600, 900, 1500 & 2500, API 2000, 3000 & 5000
 Flanged End, Weld-End, Long Pattern, Single Disc,
 Internal Spring Assist, No Spring Assist
 ANSI B16.34, API 6A, 6D (Monogrammed), 594 & API 607 4th Edition,
 CE Mark, NACE MR0175

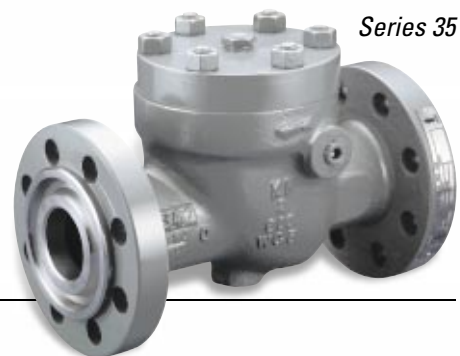

Series 35

Series 50

2" - 8", ANSI Class 300, 600 & 900
 Spring Assisted Closure,
 Precisely Metered Piston Orifice
 ANSI B16.34 & B16.5

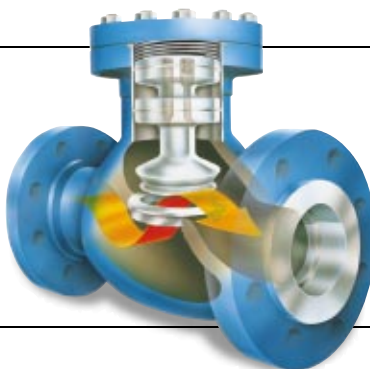

Series 50

KF Needle & Isolator Valves

Features

Packed Bonnet Style

- Available In Hard & Soft Seat For Pressures Up To 10,000 psi.
- Stainless Steel Stem & Teflon® Or Grafoil® Packing
- Optional Graphoil® Packing For Temperatures Up To 1000°F
- NACE Conformance Available

O-Ring Style

- Accurate Regulation At Pressures Up To 6000 psi For Soft Seat & 10,000 psi For Metal Seat.
- Temperature Limit 400°F
- NACE Conformance Available

Packed Bonnet & O-Ring Style Needle Valves

Carbon or Stainless Steel Body
 Packed Bonnet - 1/4" - 1" NPT, Up to 10,000 psi
 O-Ring - 1/4" - 1/2" NPT, Soft Seated, Up to 6000 psi,
 Metal Seated, Up to 10,000 psi

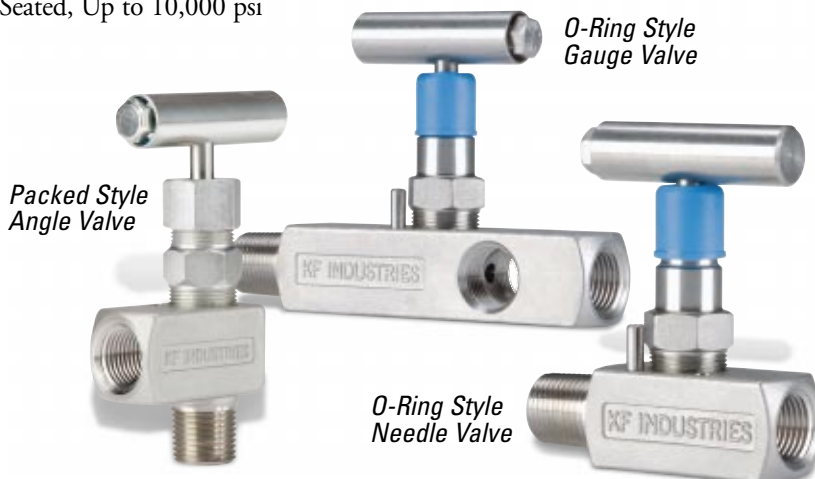

Packed Style Angle Valve

O-Ring Style Gauge Valve

O-Ring Style Needle Valve

Features

- Enables Isolation Of The Safety Relief Valve From The Pressure Source For Relieving Set Point Verification Without Shutdown Or Removal
- Latch-Lock Handles On Isolator & Test Port Valve
- Seal Welded Body & Test Port Valve

KF-AIV Isolator Valves

Carbon or Stainless Steel Body
 1" - 2" NPT, 1500 - 5000 psi
 1" - 6" ANSI Flanged, 150 - 1500 psi

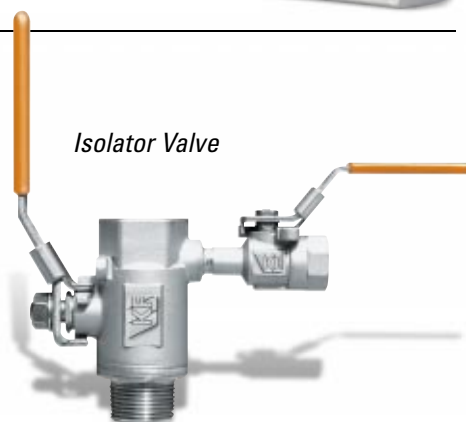

Isolator Valve



KF Butterfly Valves

Features

- Installs Between ANSI 125 Or 150 Flanges
- PTFE Bushings 2"-12"
- Bronze Bushings 14"-36"
- Lugged Style Valves Suitable For Bi-Directional Dead End Service At Full Rated Pressure
- Seats Available In Buna N & Viton® A
- One-Piece Shaft Through 24"
- Direct Mount Topworks (2"-10")
- 29" HG Vacuum Rating
- ISO 5211 Topworks

Specifications

MSS SP-67
API 609

Series BG

2"-36", Wafer or Lug Ductile Iron Body
2"-12", 200 PSI
14"-36", 150 PSI

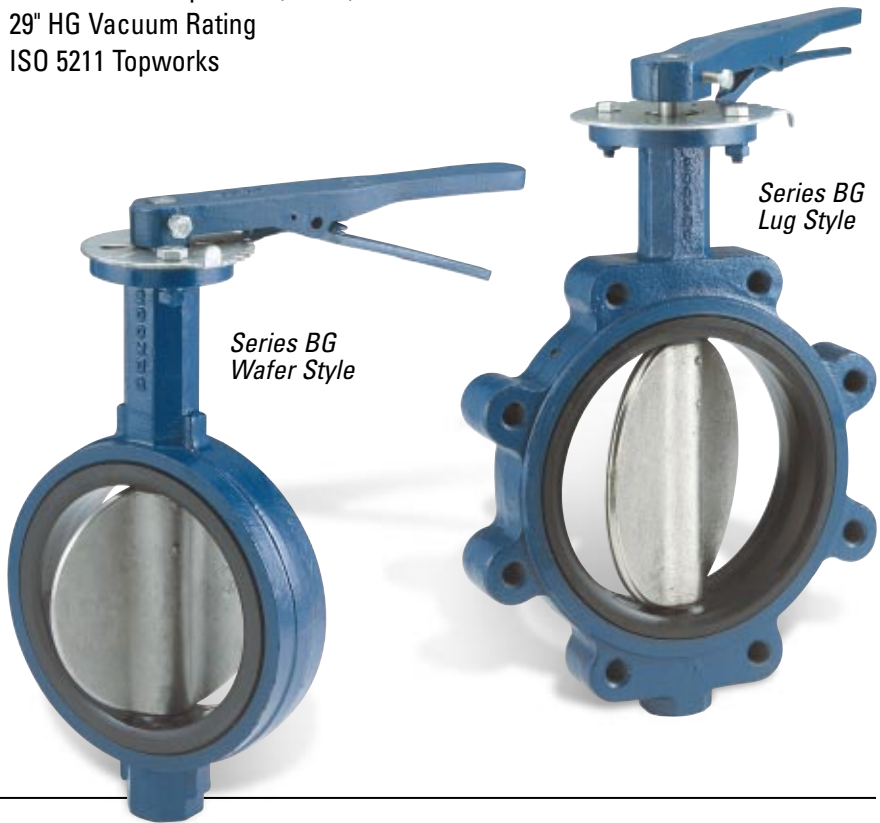

Features

- Lockable Handle, Easily Locked In Full Open Or Full Closed Position
- Maximum Size Stem Diameter Offers Greater Strength & Increases the Life Of The Valve
- Standard Polished Bronze Disc With Replaceable Buna N O-Ring
- Optional Fluoroelastomer O-Ring Material Is Available.
- Disc & Stem O-Rings Are Easily Replaced In The Field
- One-Piece Cast Iron, Nickel Plated Body For Corrosion Resistance
- Trim For Salt Water Is Available

Series 2200

One-Piece Cast Iron Body
(Electro Plated Nickel)
2"-6", 200 WOG



KF Specialty Ball Valves

Features

- NACE MR0175
- Mounting Pad For Automation
- Locking Handle

Series K1

One-Piece Stainless Steel
Investment Cast Body
1/4" - 2" NPT, 2000 psi

Series K3

Rugged Three-Piece
Forged Steel Design
1/4" - 2" NPT
3000 & 6000 psi, A105 & A350-LF2 Material



TOP FLOW Rubber Seated Gate Valve

Features

- Engineered & Manufactured For Severe Oilfield Applications Including Well Treating & Frac Service, High Pressure Mud Mixing Lines, Production Manifolds & Standpipe Manifolds
- Easy To Replace Seats For Positive Sealing

Series TG

Carbon Steel Body
4" ANSI 400 & API 3000

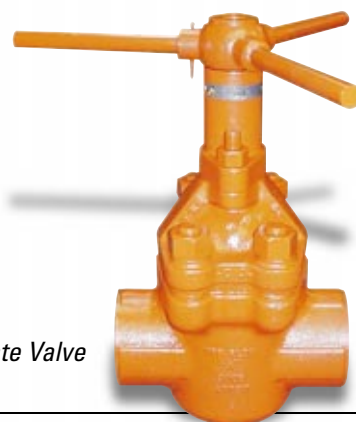

Gate Valve

KF Gate, Globe & Check Valves

Forged Steel - In a wide range of steel materials including ASTM A105N, A350-LF2, A182-F11-F5-F304-F316 & F316L
1/4" - 2", ANSI Class 800-2500

Cast Steel - In a wide range of steel materials including ASTM A216-WCB, A352-LCC, A217-C5 & A351-CF8M
2" - 48", ANSI Class 150-2500



Forged Steel Valves



Cast Steel Valves

TOP FLOW Quick Opening Closures

Features

- Manufactured to ASME BPVC Section VIII Div 1 Specifications
- Each Closure Utilizes a Standard O-Ring Size

- Provides Quick Access To Piping System Interiors
- Can Be Custom Manufactured To Suit Any Application In Vertical, Horizontal Or Angled Installations

Series TC

Low Temp Carbon Steel Body
2" - 12", ASME 275-2160 psi



Closure



Worldwide Sales Offices



**KF Industries, a leading brand of CIRCOR Energy Products, Inc.
reaches into every corner of the globe serving the oil & gas and industrial marketplace.**

**Supplying an extensive range of product offerings
through a worldwide network of manufacturer representatives and distributors,
KF Industries is the right choice for all your flow control needs.**

World Headquarters

KF Industries
1500 S.E. 89th Street
Oklahoma City, OK 73149 USA
Phone: (405) 631-1533
Fax: (405) 631-5034
E-mail: sales@circorenergy.com
www.circorenergy.com

US Industrial

KF Contromatics Industrial Products
1500 S.E. 89th Street
Oklahoma City, OK 73149 USA
Phone: (405) 631-1533
Fax: (405) 631-5034
E-mail: sales@circorenergy.com
www.circorenergy.com

Canada

KF Industries Canada
9430-39th Avenue, Edmonton
Alberta, Canada T6E 5T9
Phone: (780) 463-8633
Fax: (780) 461-1588
E-mail: kfinfo@circorenergy.com
www.circorenergy.com



Licensed for Manufacture
in accordance with API 6A
& 6D and Firetest
to API 6FA and 607



Registered to the ISO 9001
Quality System Standard,
accredited by U.K., Dutch
and German qualifying
authorities.



www.circorenergy.com